



CHONGQING CLOUDCHILD TECHNOLOGY CO.,LTD

SOT-23 Plastic-Encapsulate MOSFETS

BSS84K

P-Channel Power MOSFET

V_{DS}	$R_{DS(ON)}$ (Typ.)	I_D
-50 V	2.3Ω@-10V 2.7Ω@-4.5V	-0.18A

DESCRIPTION

The BSS84K provides excellent $R_{DS(ON)}$ with low gate charge.

It can be used in a wide variety of applications.

FEATURES

- Trench Technology MOSFET
- Low Gate Charge
- AEC-Q101 Qualified

APPLICATIONS

- Load Switch for Portable Devices
- DC/DC Converter

MARKING

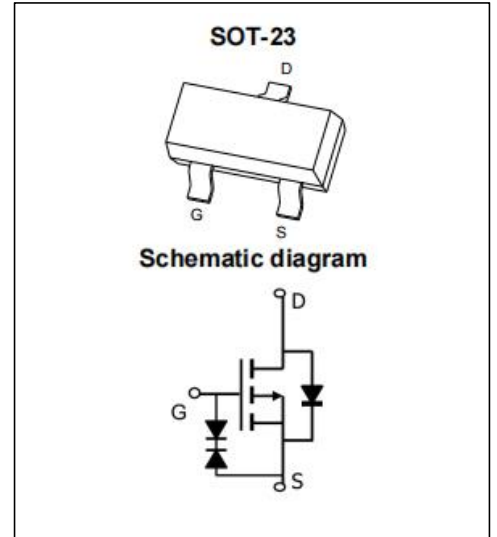
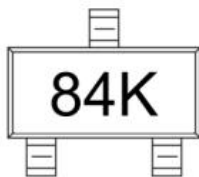

ABSOLUTE MAXIMUM RATINGS($T_J=25^{\circ}\text{C}$ unless otherwise specified)

Parameter	Symbol	Value	Unit
Drain-Source Voltage	V_{DSS}	-50	V
Gate-Source Voltage	V_{GS}	± 20	V
Continuous Drain Current ¹	I_D	-0.18	A
Pulsed Drain Current ²	I_{DM}	-0.72	A
Total Power Dissipation ⁴	P_D	361	mW
Thermal Resistance from Junction to Ambient	$R_{\theta JA}$	415	$^{\circ}\text{C}/\text{W}$
Junction Temperature	T_J	175	$^{\circ}\text{C}$
Storage Temperature	T_{STG}	-55~ +175	$^{\circ}\text{C}$

MOSFET ELECTRICAL CHARACTERISTICS($T_C=25^{\circ}\text{C}$ unless otherwise noted)

Parameter	Symbol	Test Condition	Min	Type	Max	Unit
Static Characteristics						
Drain-source breakdown voltage	$V_{(BR)DSS}$	$V_{GS} = 0V, I_D = -250\mu\text{A}$	-50			V
Zero gate voltage drain current	I_{DSS}	$V_{DS} = -50V, V_{GS} = 0V$			-1	μA
Gate-body leakage current	I_{GSS}	$V_{GS} = \pm 20V, V_{DS} = 0V$			± 100	nA
Gate threshold voltage ³	$V_{GS(th)}$	$V_{DS} = V_{GS}, I_D = -250\mu\text{A}$	-0.9	-1.6	-2.25	V
Drain-source on-resistance ³	$R_{DS(on)}$	$V_{GS} = -10V, I_D = -0.1A$		2.3	6	Ω
		$V_{GS} = -4.5V, I_D = -0.1A$		2.7	7	
Dynamic characteristics						
Input Capacitance	C_{iss}	$V_{DS} = -25V, V_{GS} = 0V, f = 1\text{MHz}$		30.4		pF
Output Capacitance	C_{oss}			7.51		
Reverse Transfer Capacitance	C_{rss}			4.22		
Switching Characteristics						
Total Gate Charge	Q_g	$V_{DS} = -10V, V_{GS} = -10V, I_D = -0.1A$		0.59		nC
Gate-Source Charge	Q_{gs}			0.12		
Gate-Drain Charge	Q_{gd}			0.09		
Turn-on delay time	$t_{d(on)}$	$V_{DD} = -30V, V_{GS} = 10V, R_G = 50\Omega, R_L = 110\Omega$		10		ns
Turn-on rise time	t_r			5.5		
Turn-off delay time	$t_{d(off)}$			17.5		
Turn-off fall time	t_f			6		
Diode Characteristics						
Continuous Source Current	I_S	---		-0.18		A
Diode Forward Voltage ³	V_{SD}	$V_{GS} = 0V, I_S = -0.1A, T_J = 25^{\circ}\text{C}$			-1.2	V

Note :

1. The maximum current rating is limited by Chip.
2. Pulse Test : Pulse Width $\leq 10\mu\text{s}$, duty cycle $\leq 1\%$.
3. Pulse Test : Pulse Width $\leq 300\mu\text{s}$, duty cycle $\leq 2\%$.
4. The power dissipation P_D is limited by $T_{J(MAX)} = 175^{\circ}\text{C}$.

Characteristics Curve:

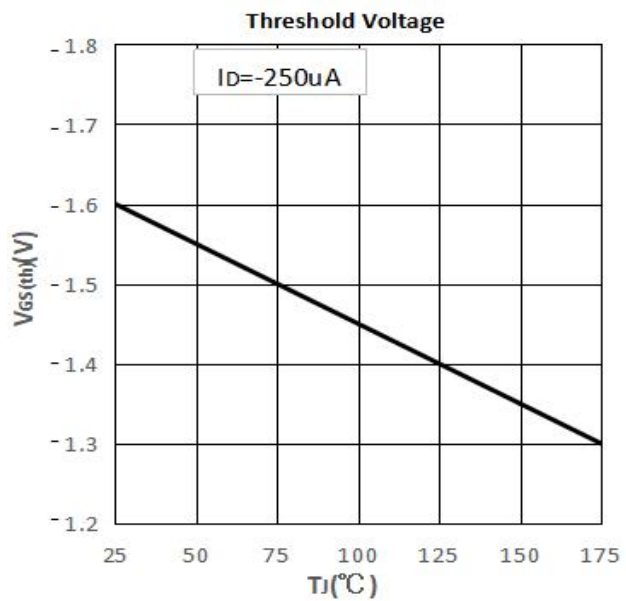
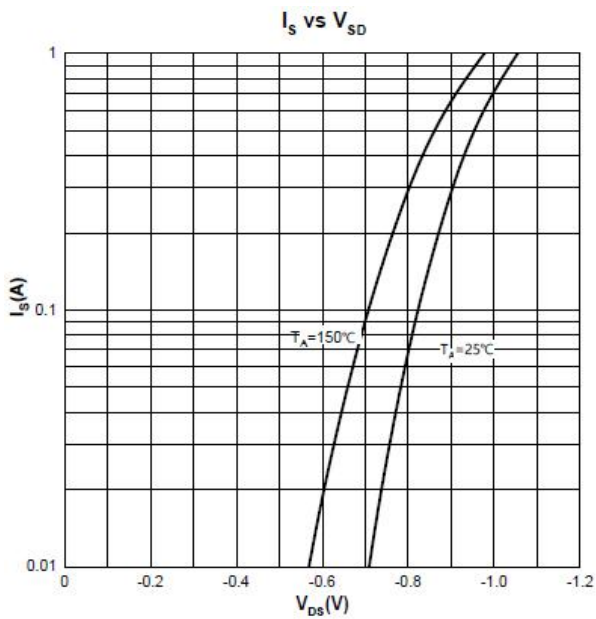
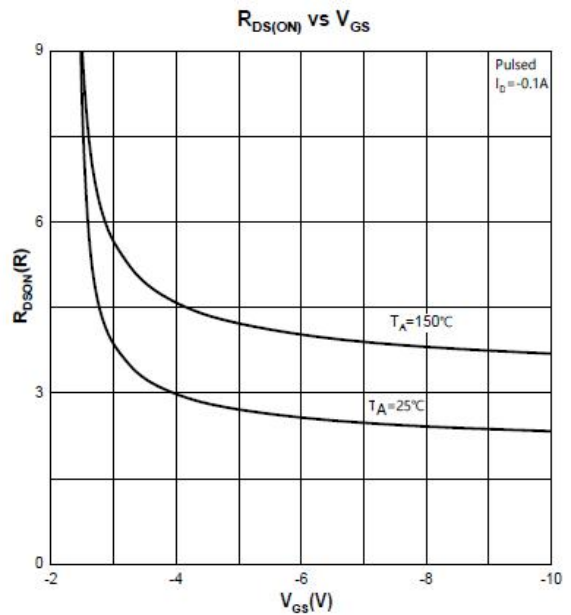
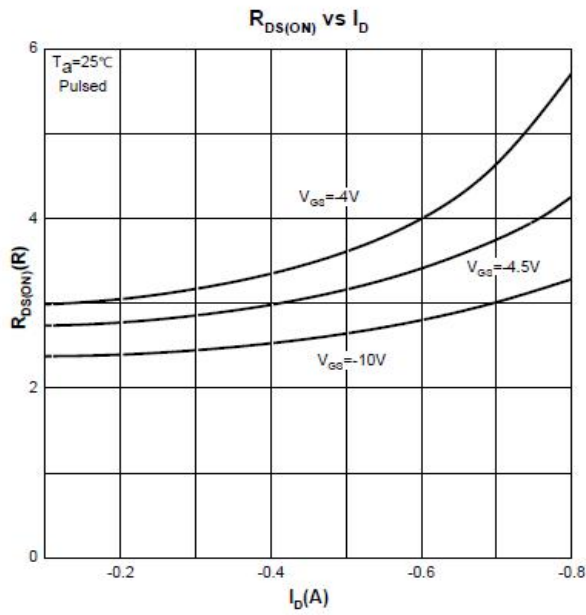
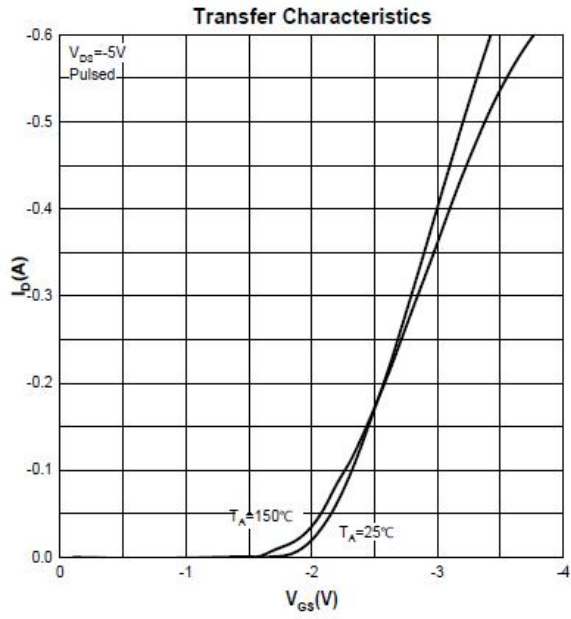
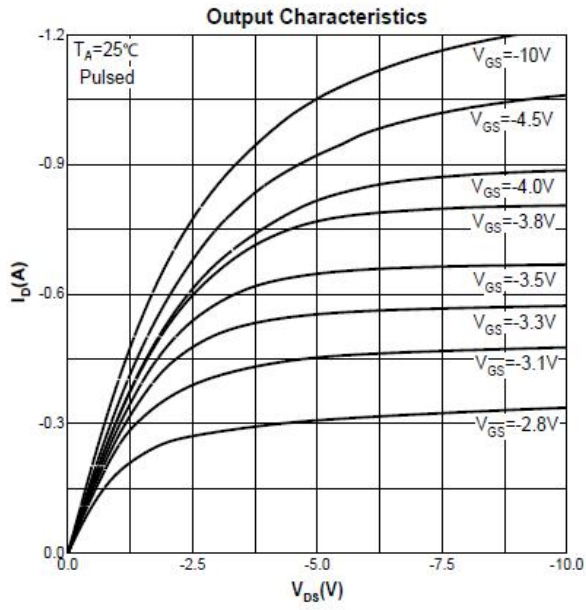

Maximum Forward Biased Safe Operating Area

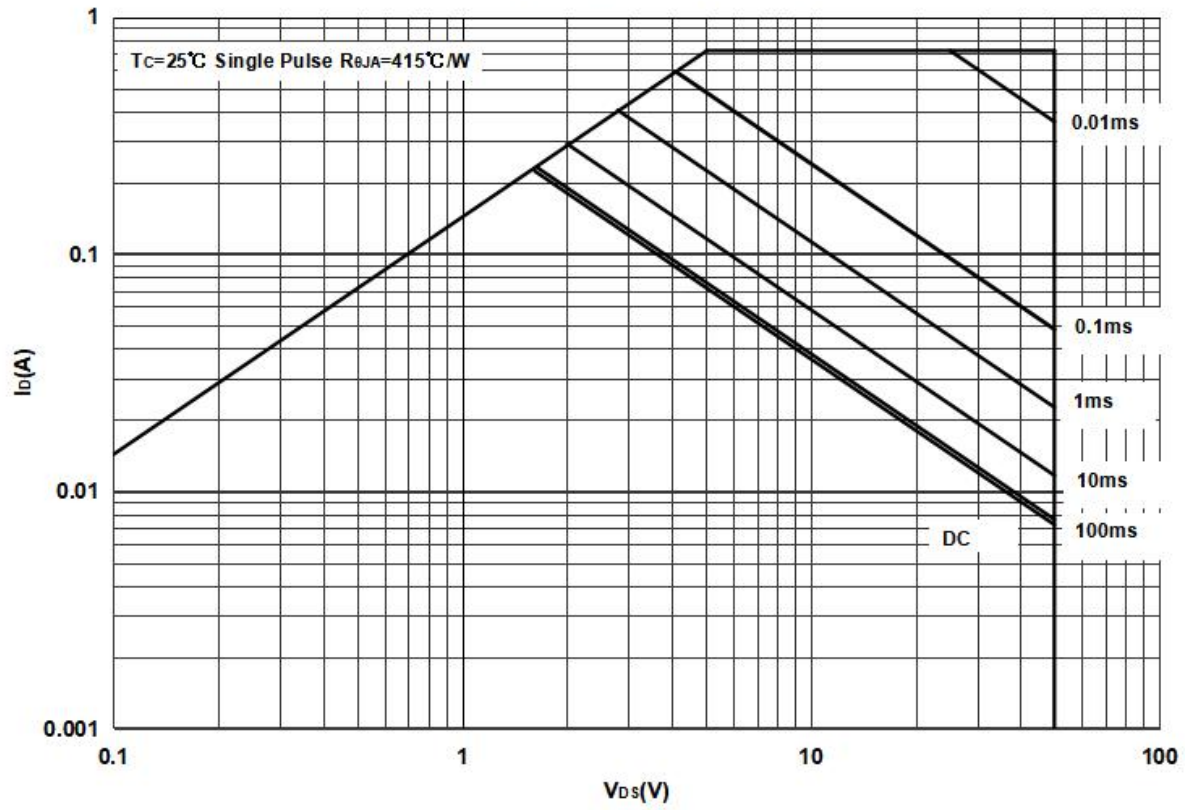

Normalized Thermal Transient Impedance

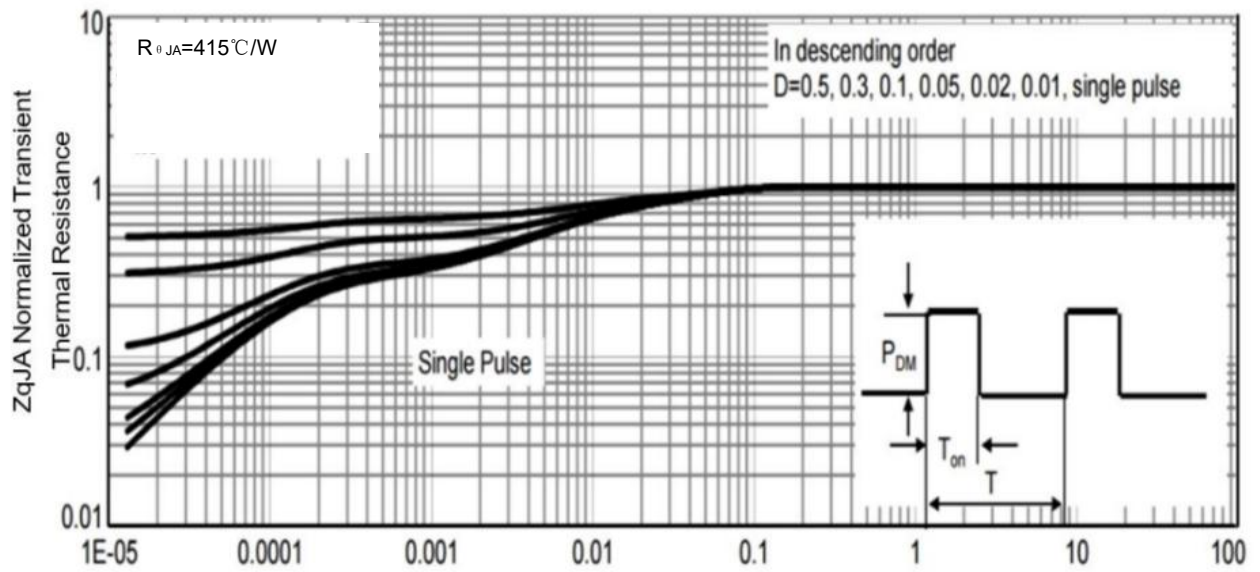

SOT-23 Package Outline Dimensions

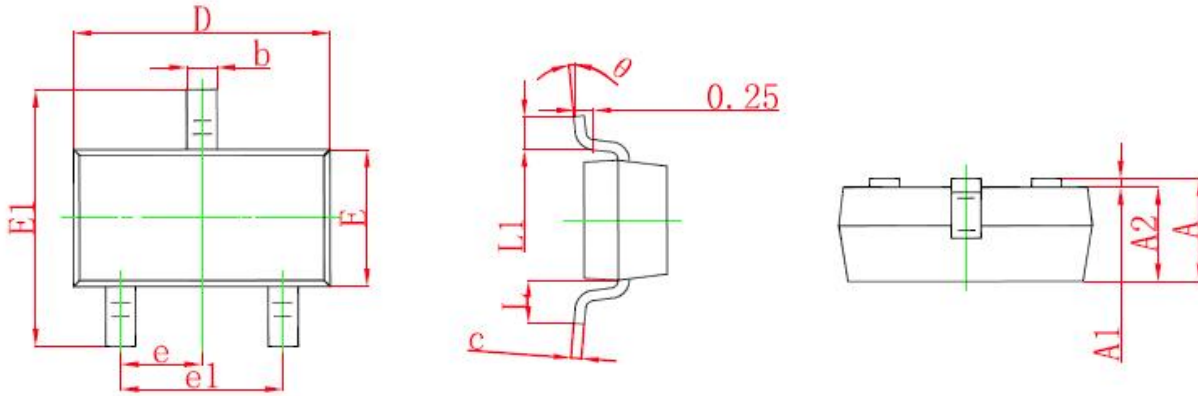

Symbol	Dimensions In Millimeters		Dimensions In Inches	
	Min	Max	Min	Max
A	0.900	1.150	0.035	0.045
A1	0.000	0.100	0.000	0.004
A2	0.900	1.050	0.035	0.041
b	0.300	0.500	0.012	0.020
c	0.080	0.150	0.003	0.006
D	2.800	3.000	0.110	0.118
E	1.200	1.400	0.047	0.055
E1	2.250	2.550	0.089	0.100
e	0.950 TYP		0.037 TYP	
e1	1.800	2.000	0.071	0.079
L	0.550 REF		0.022 REF	
L1	0.300	0.500	0.012	0.020
θ	0°	8°	0°	8°

SOT-23 Suggested Pad Layout

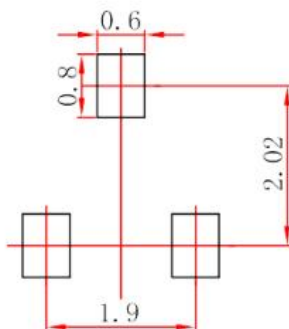

Note:

1. Controlling dimension: in millimeters.
2. General tolerance: $\pm 0.05\text{mm}$.
3. The pad layout is for reference purposes only.

NOTICE

Cloudchild reserve the right to make modifications, enhancements, improvements, corrections or other changes without further notice to any product herein. Cloudchild does not assume any liability arising out of the application or use of any product described herein.

ChongQing Cloudchild Technology Co., Ltd. (short for Cloudchild) exerts the greatest possible effort to ensure high quality and reliability. Nevertheless, semiconductor devices in general can malfunction or fail due to their inherent electrical sensitivity and vulnerability to physical stress. It is the responsibility of the buyer, when utilizing Cloudchild products, to comply with the standards of safety in making a safe design for the entire system, including redundancy, fire-prevention measures, and malfunction prevention, to prevent any accidents, fires, or community damage that may ensue. In developing your designs, please ensure that Cloudchild products are used within specified operating ranges as set forth in the most recent Cloudchild products specifications.

SOT-23 Tape and reel

SOT-23 Embossed Carrier Tape

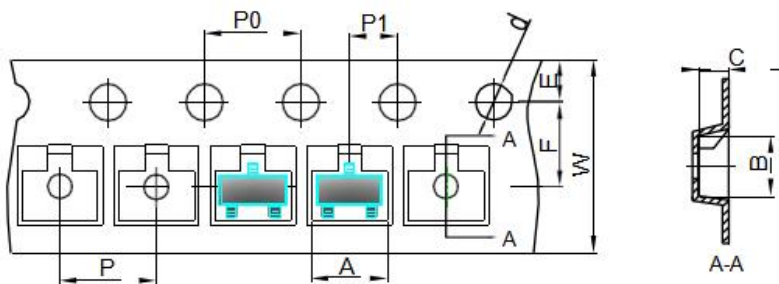

Packaging Description:

SOT-23 parts are shipped in tape. The carrier tape is made from a dissipative (carbon filled) polycarbonate resin. The cover tape is a multilayer film (Heat Activated Adhesive in nature) primarily composed of polyester film, adhesive layer, sealant, and anti-static sprayed agent. These reeled parts in standard option are shipped with 3,000 units per 7" or 17.8cm diameter reel. The reels are clear in color and is made of polystyrene plastic (anti-static coated).

Dimensions are in millimeter

Pkg type	A	B	C	d	E	F	P0	P	P1	W
SOT-23	3.15	2.77	1.22	Ø1.50	1.75	3.50	4.00	4.00	2.00	8.00

SOT-23 Tape Leader and Trailer

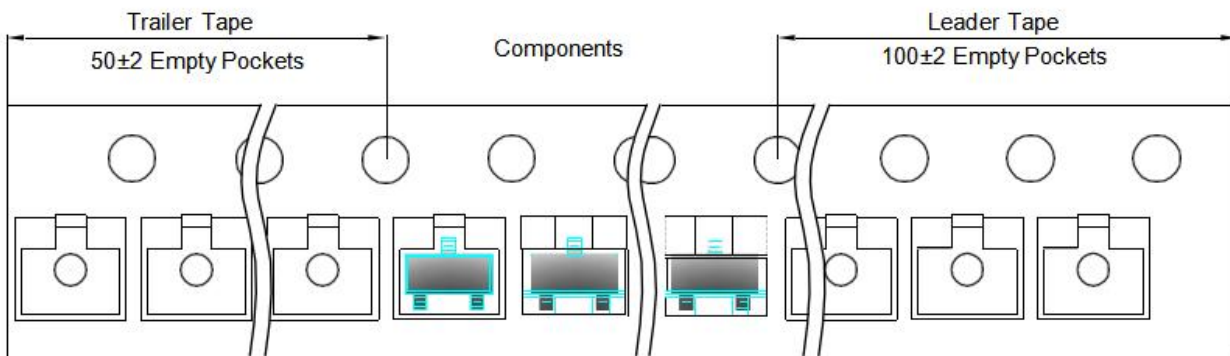

SOT-23 Reel

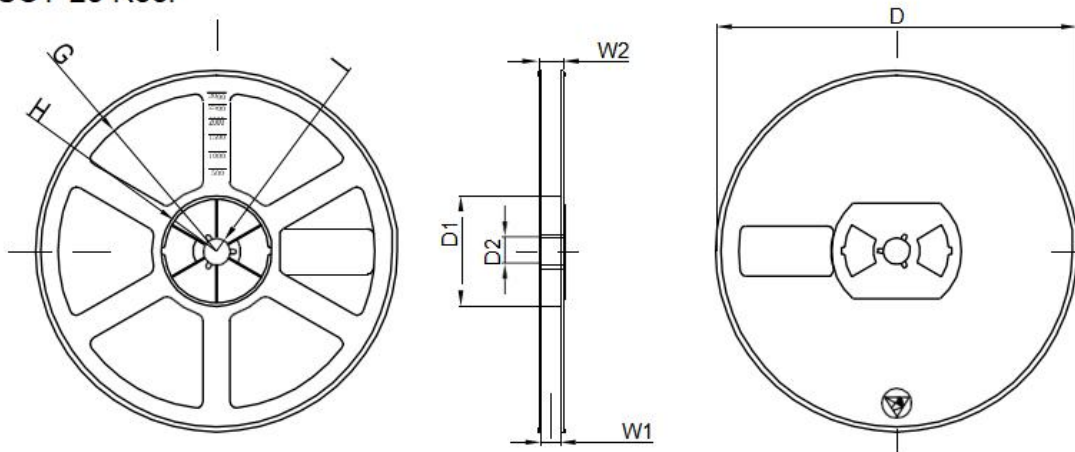

Dimensions are in millimeter

Reel Option	D	D1	D2	G	H	I	W1	W2
7" Dia	Ø178.00	54.40	13.00	R78.00	R25.60	R6.50	9.50	12.30

REEL	Reel Size	Box	Box Size(mm)	Carton	Carton Size(mm)	G.W.(kg)
3000 pcs	7 inch	30,000 pcs	203×203×195	120,000 pcs	438×438×220	

Date of change	Rev #	revise content
2023/2/24	A/0	/