



DSS22-DSS210 Plastic-Encapsulate Diodes

DSS22-DSS210 Schottky Rectifier

Features

- I_o 2A.
- VRRM 20V-100V.
- High surge current capability.
- Polarity:Color band denotes cathode.
- AEC-Q101 Qualified.

Application

- Rectifier.

Marking

- DSS22-DSS210: S22-S210.

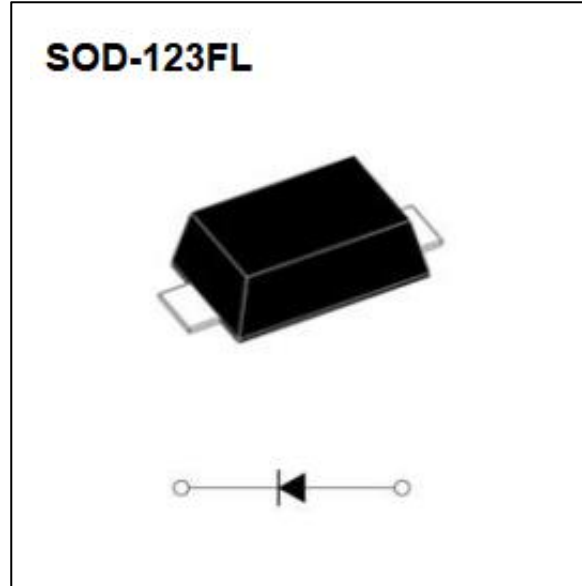

ABSOLUTE MAXIMUM RATINGS (T_a=25°C unless otherwise noted)

Item	Symbol	Unit	Test Conditions	DSS						
				22	23	24	25	26	28	210
Repetitive Peak Reverse Voltage	V _{RRM}	V		20	30	40	50	60	80	100
Maximum RMS Voltage		V		20	30	40	50	60	80	100
Average Forward Current	I _{F(AV)}	A	60HZ Half-sine wave, Resistance load, TL(Fig.1)	2.0						
Surge(Non-repetitive)Forward Current	I _{FSM}	A	60Hz Half-sine wave, 1 cycle, T _a =25°C	40						
Junction Temperature	T _J	°C		-55 ~ +150						
Storage Temperature	T _{STG}	°C		-55 ~ +150						

ELECTRICAL CHARACTERISTICS (T_a=25°C unless otherwise noted)

Item	Symbol	Unit	Test Condition	DSS							
				22	23	24	25	26	28	210	
Peak Forward Voltage	V _F	V	I _F =2.0A	0.55			0.70		0.85		
Peak Reverse Current	I _{R_{RM}1}	mA	V _{RM} =V _{R_{RM}} T _a =25°C	0.5						0.1	
	I _{R_{RM}2}			10			5.0				
Thermal Resistance(Typical)	R _{θJ-A}	°C/ W	Between junction and ambient	75 ¹⁾							
	R _{θJ-L}		Between junction and terminal	17 ¹⁾							

Notes:

Thermal resistance from junction to ambient and from junction to lead mounted on P.C.B. with 0.2" x 0.2" (5.0 mm x 5.0 mm) copper pad areas.

Typical Characteristics

FIG.1: FORWARD CURRENT DERATING CURVE

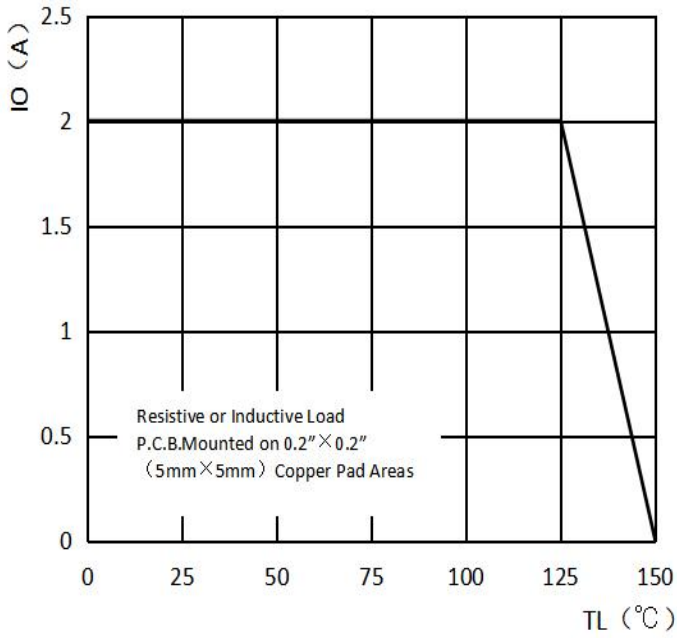

FIG.2: MAXIMUM NON-REPETITIVE FORWARD URGE CURRENT

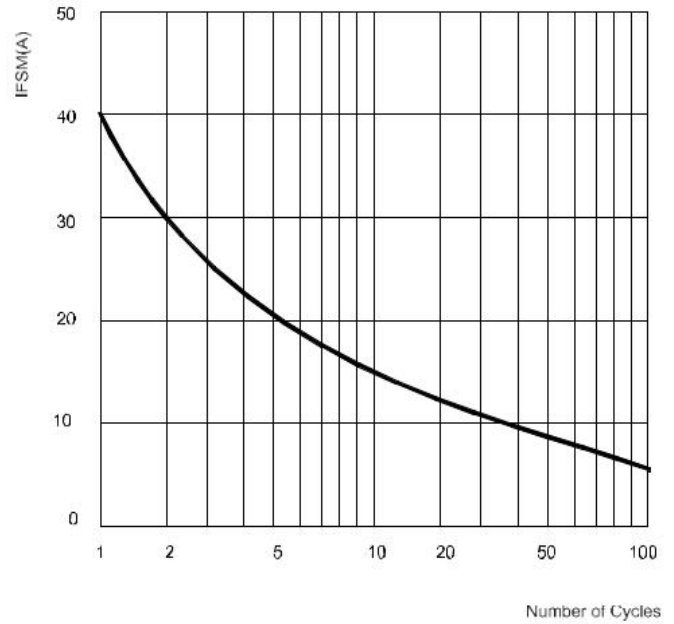

FIG.3: TYPICAL FORWARD CHARACTERISTICS

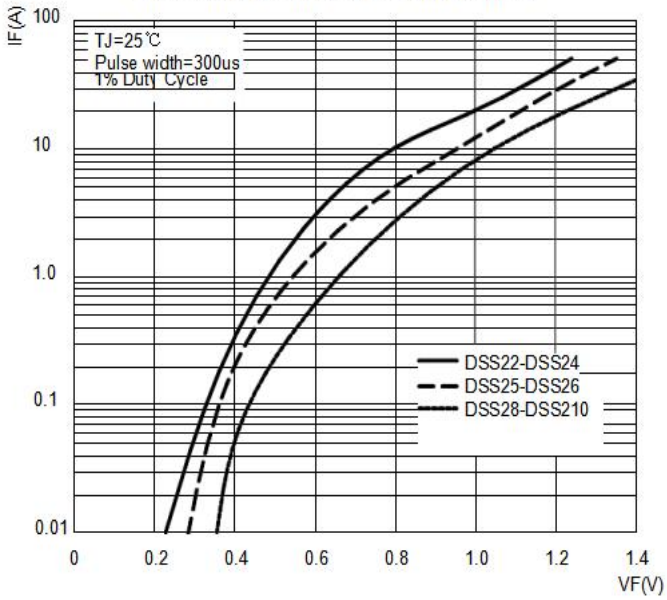
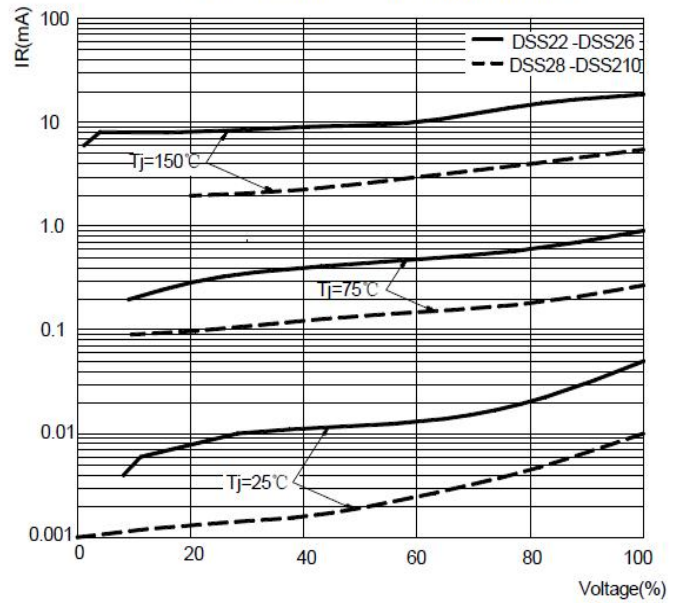
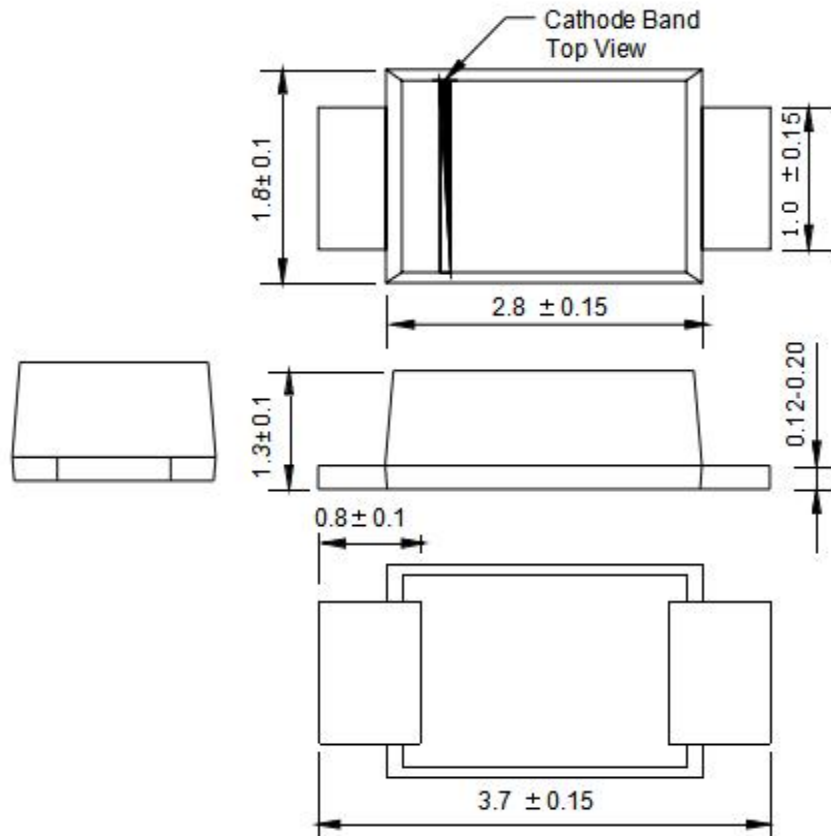

FIG.4: TYPICAL REVERSE CHARACTERISTICS



SOD-123FL Package Outline Dimensions



Dimensions in millimeters

SOD-123FL Suggested Pad Layout

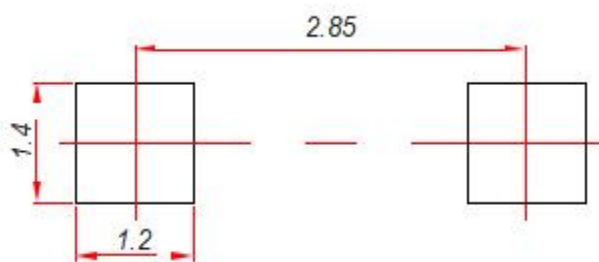

Note:

1. Controlling dimension: in millimeters.
2. General tolerance: ± 0.05 mm.
3. The pad layout is for reference purposes only.

NOTICE

CLOUDCHILD reserves the right to make modifications, enhancements, improvements, corrections or other changes without further notice to any product herein. CLOUDCHILD does not assume any liability arising out of the application or use of any product described herein.